

Play Dough Alphabet Cards

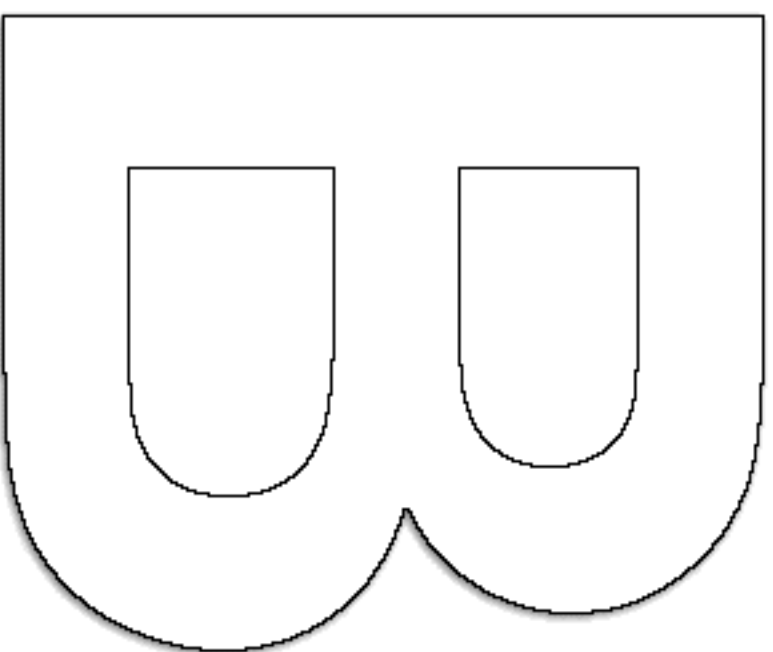

Play Dough Alphabet Cards

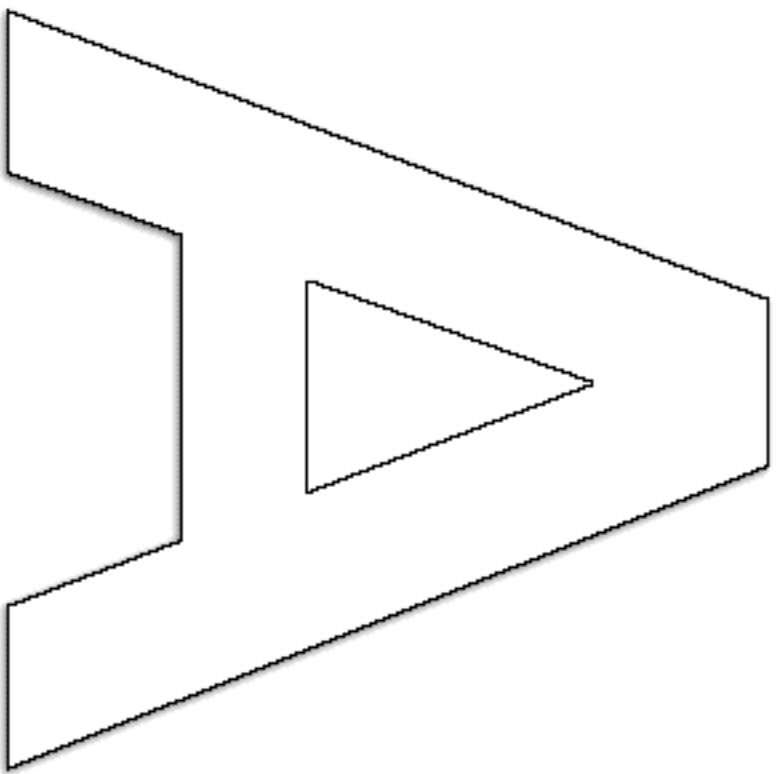
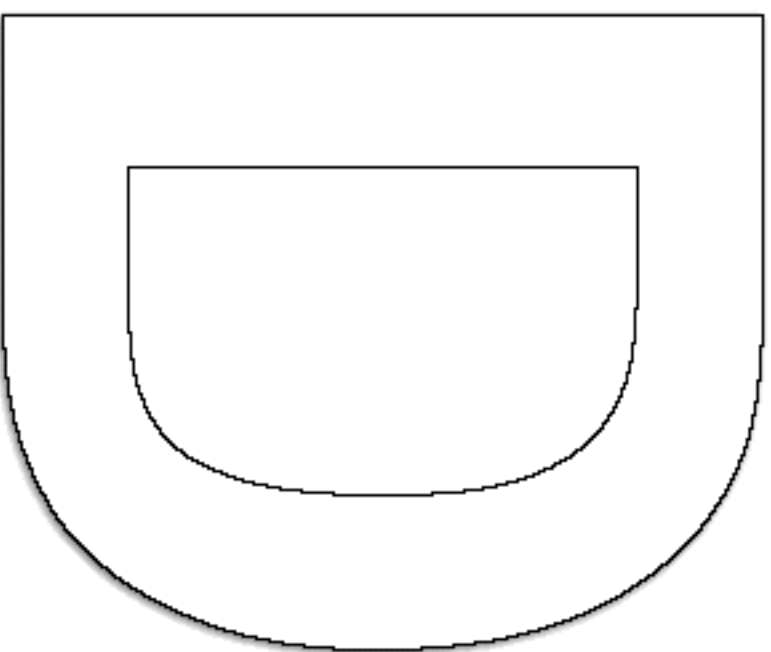
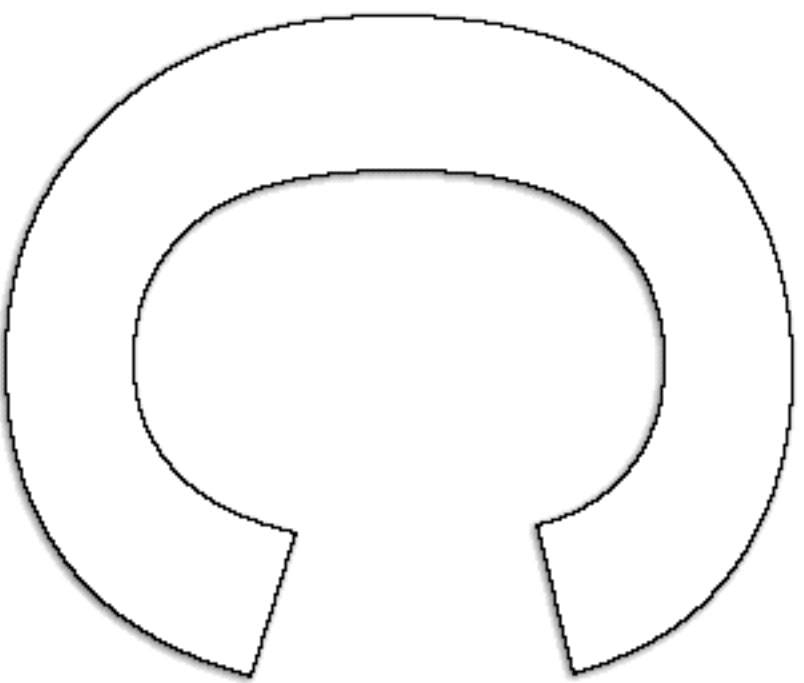

Play Dough Alphabet Cards

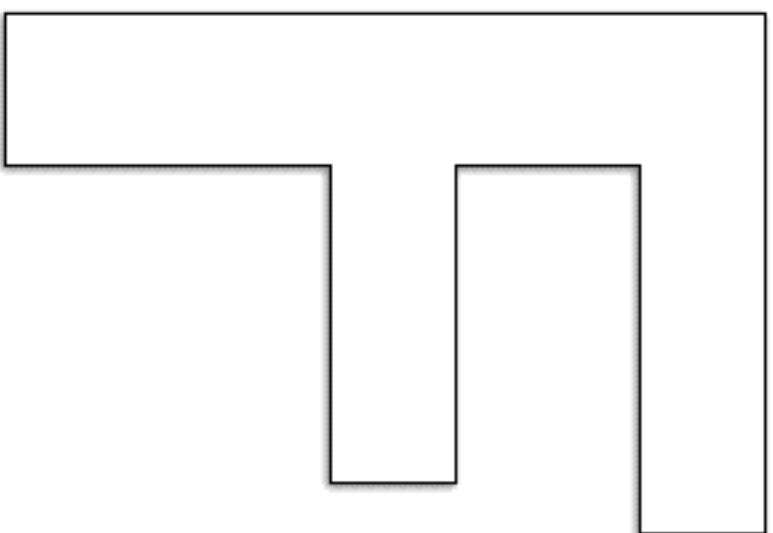
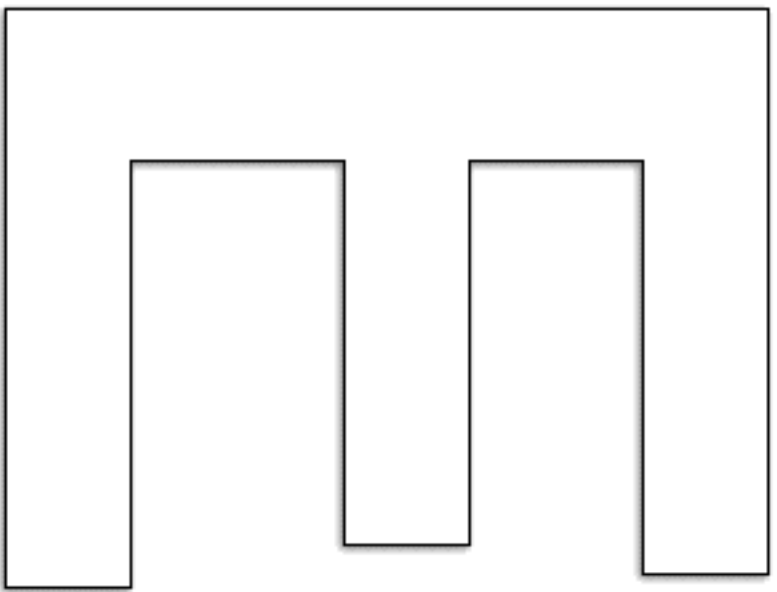

Play Dough Alphabet Cards

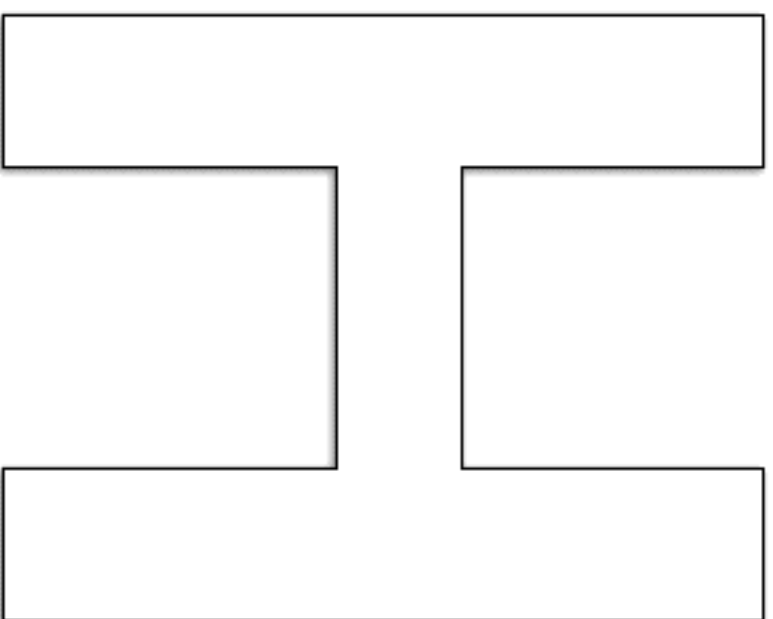
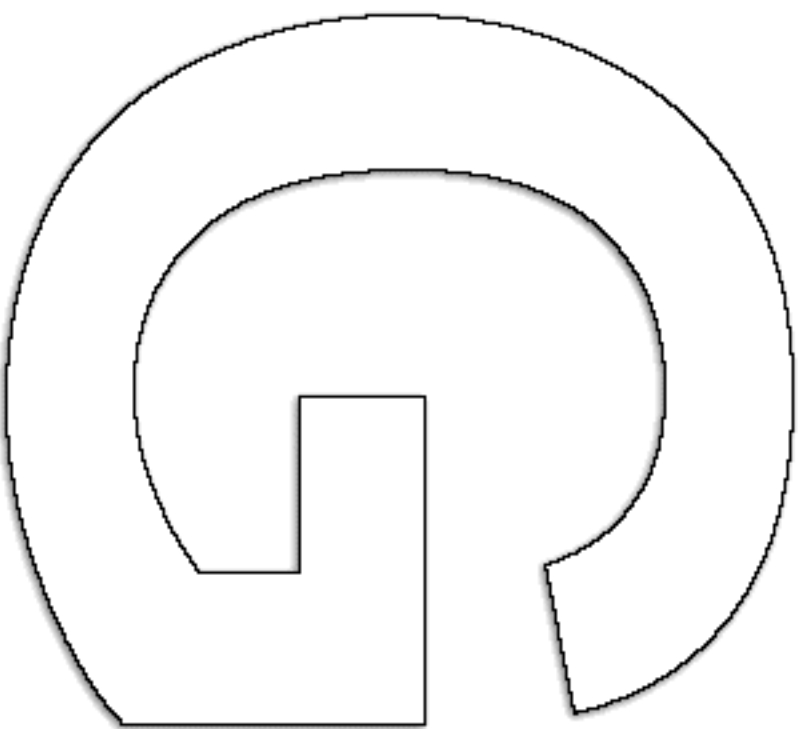

Play Dough Alphabet Cards

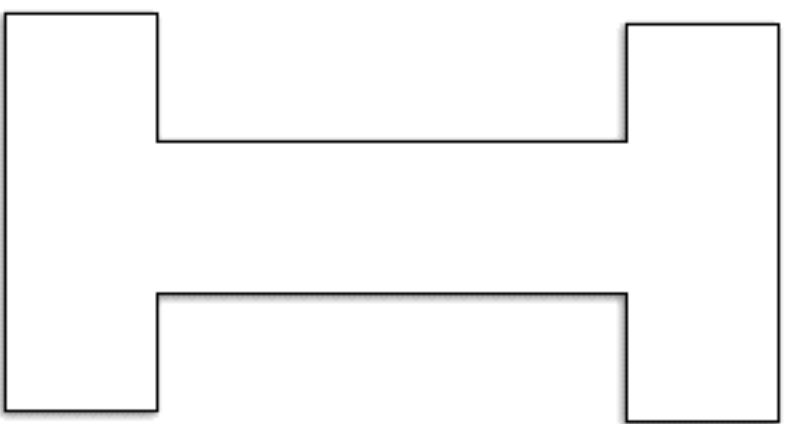

H

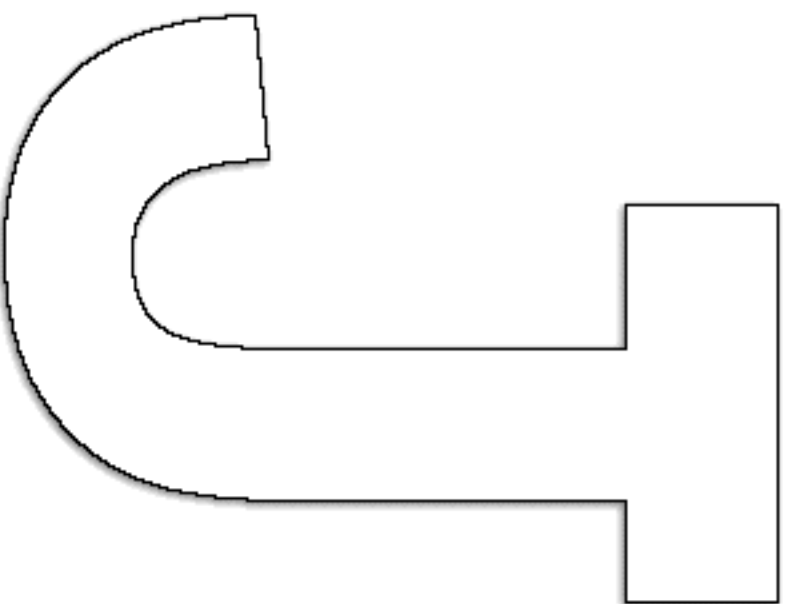

T

Play Dough Alphabet Cards

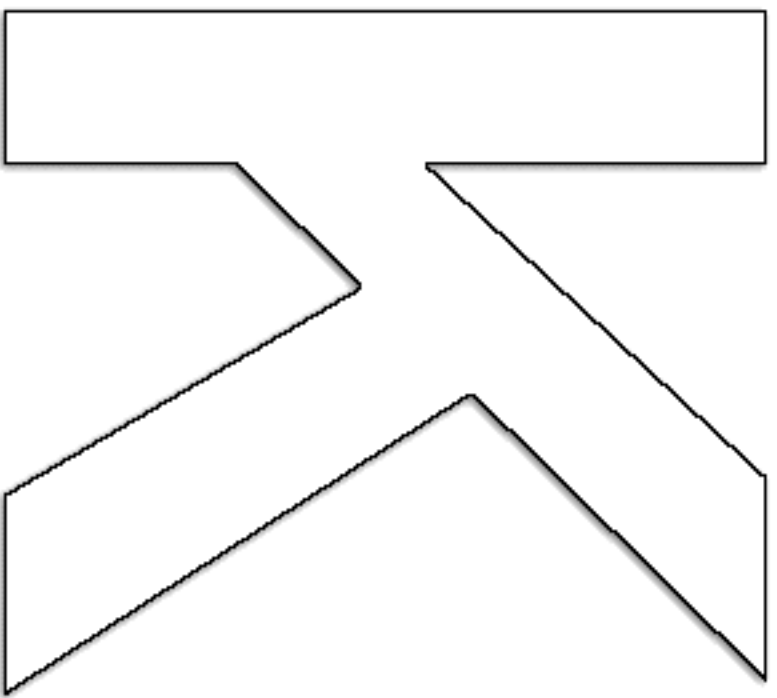

Play Dough Alphabet Cards

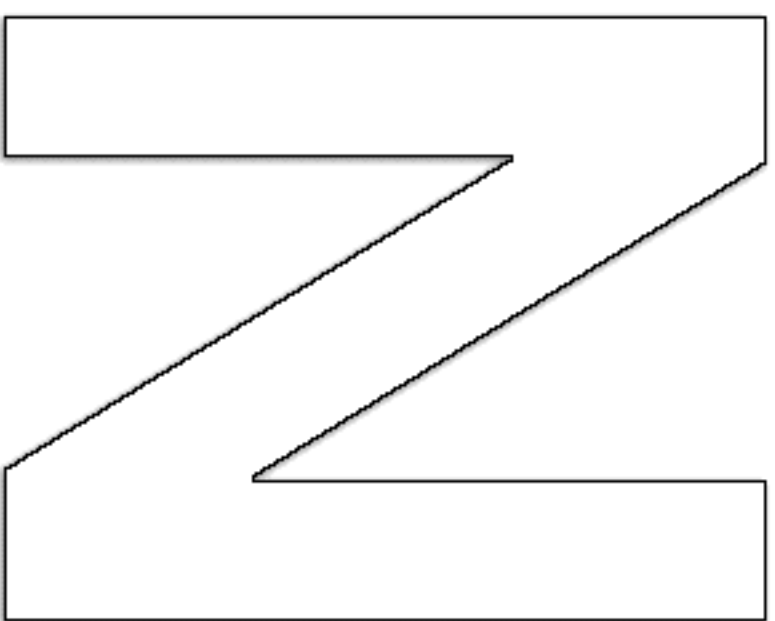
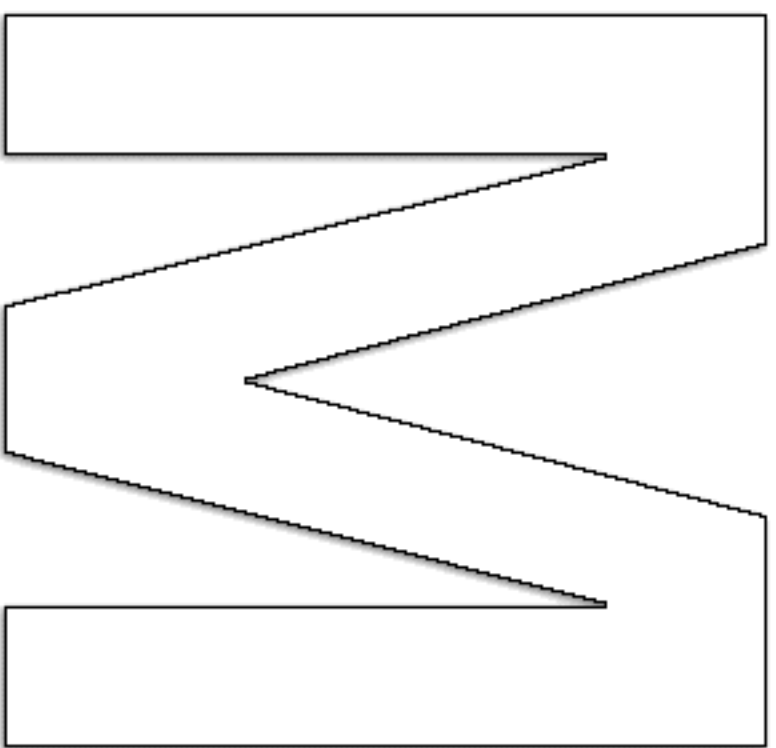

Play Dough Alphabet Cards

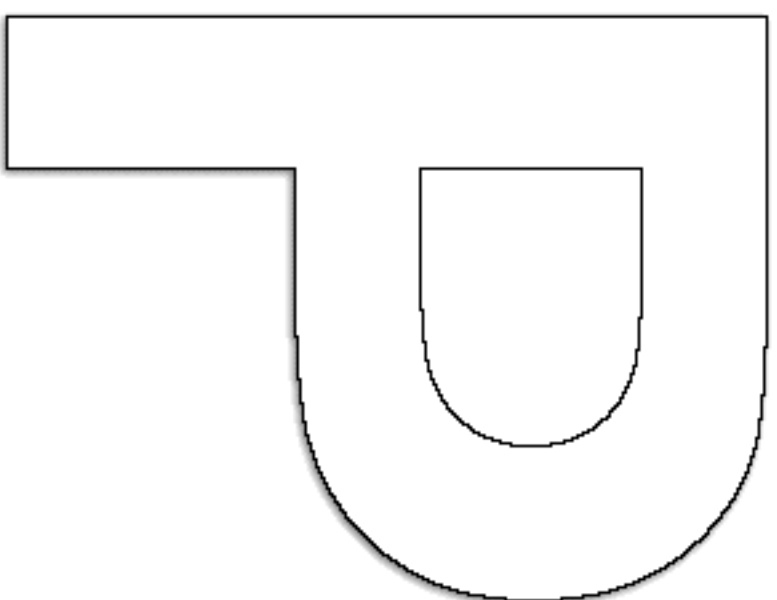
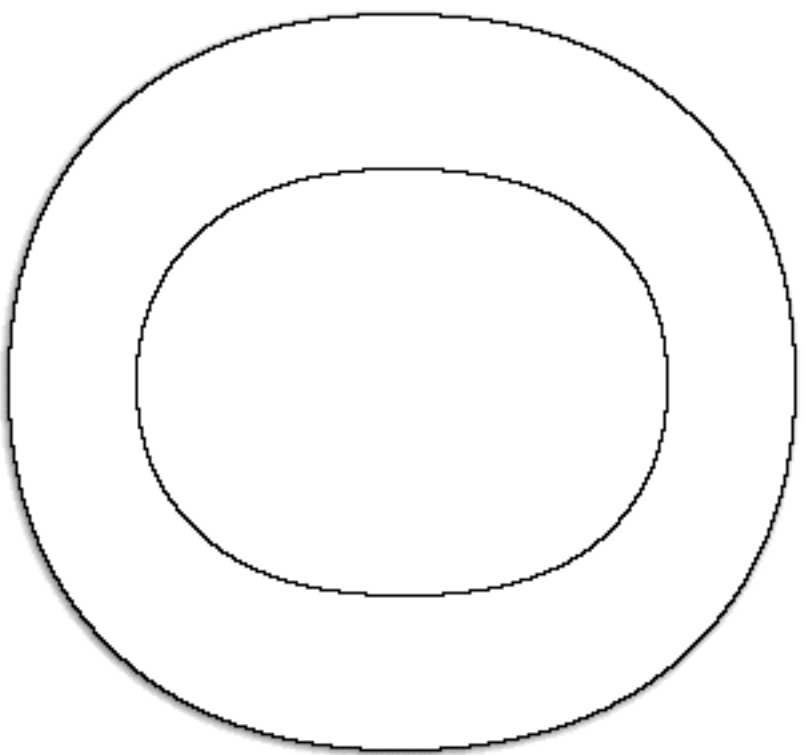

Play Dough Alphabet Cards

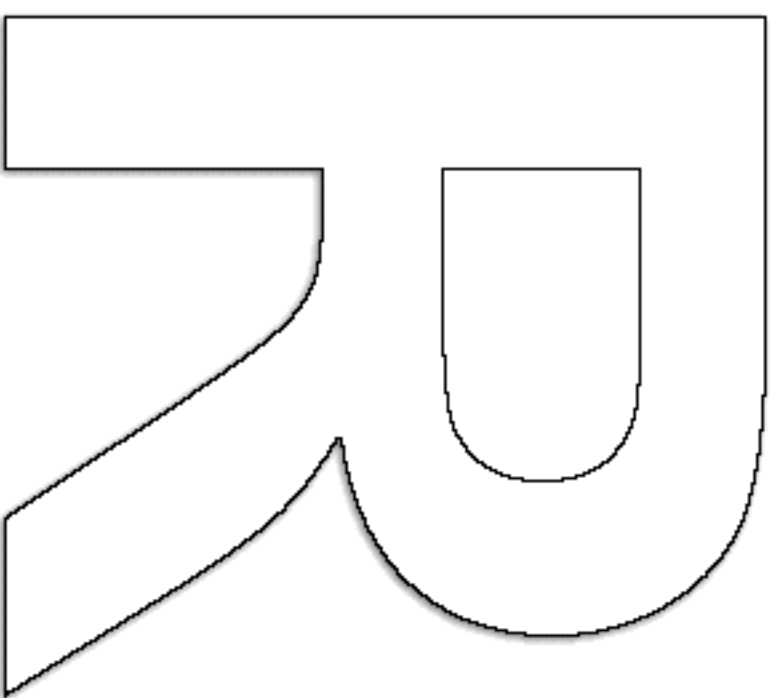
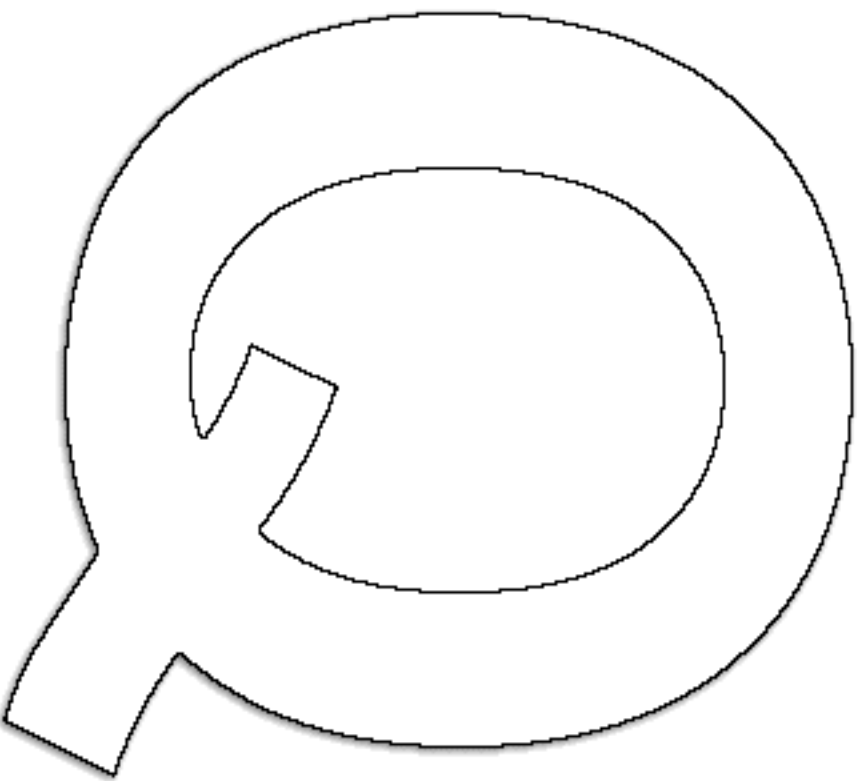

Play Dough Alphabet Cards

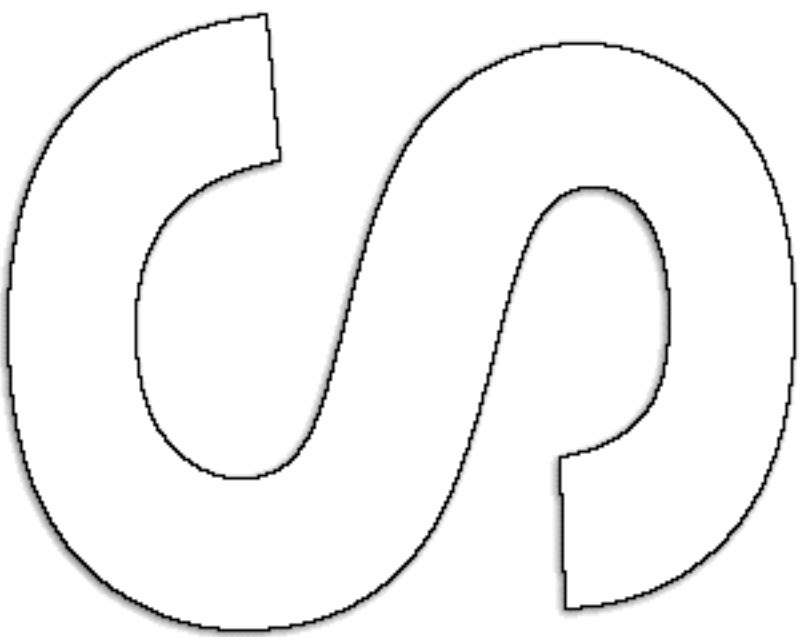

s

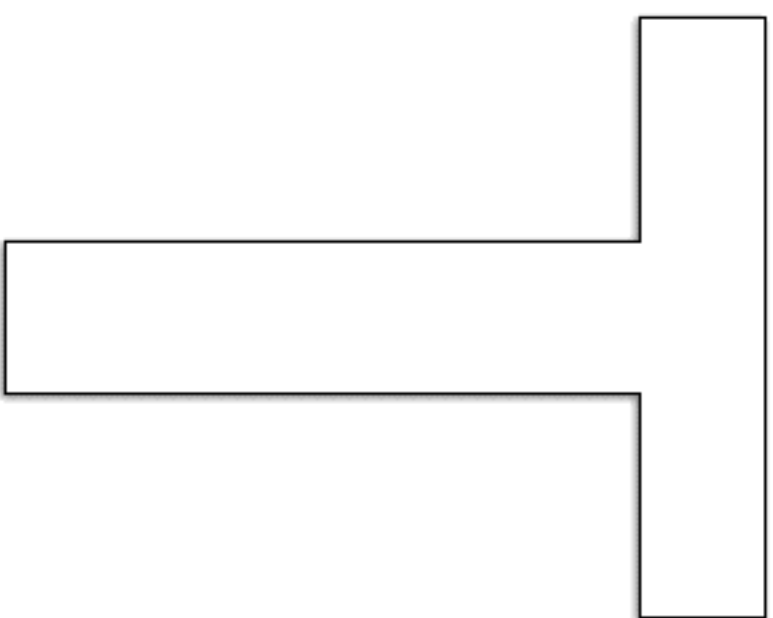

t

Play Dough Alphabet Cards

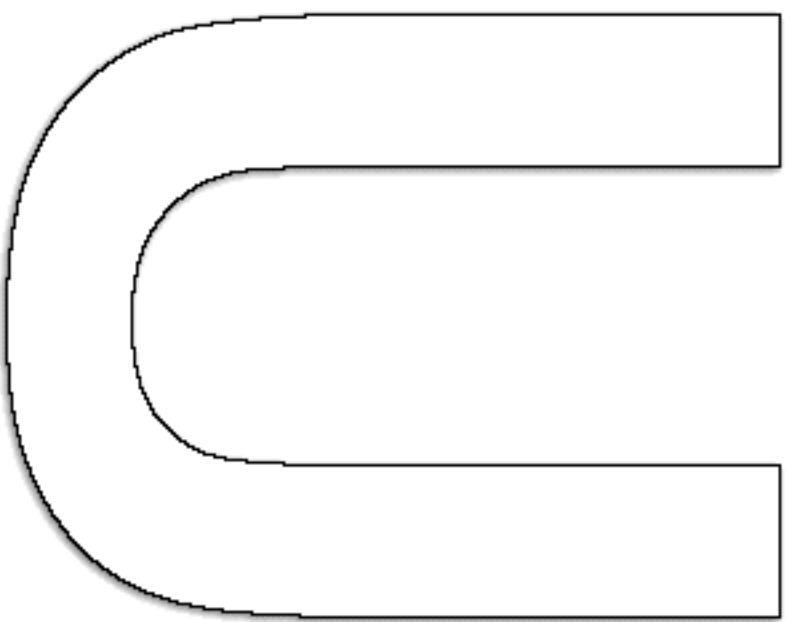

C

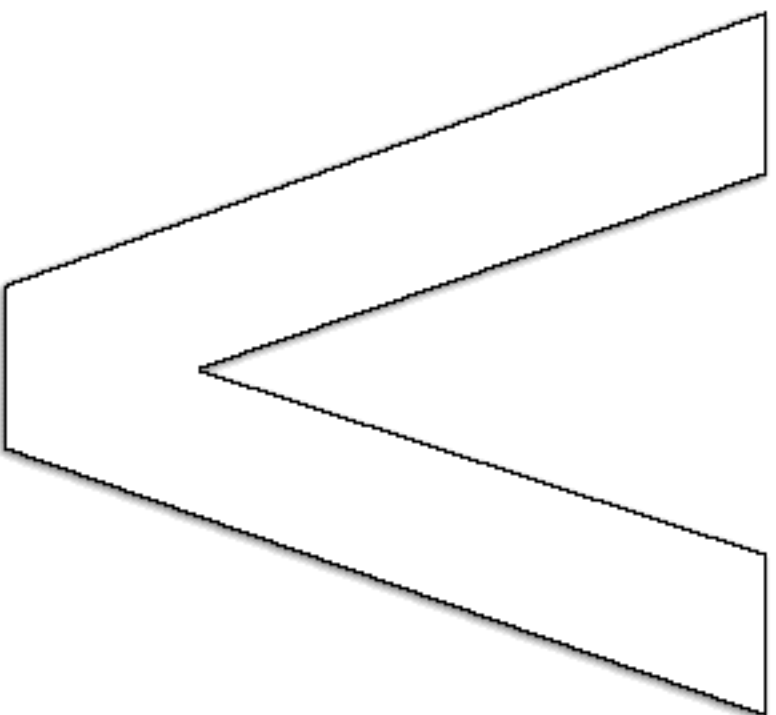

A

Play Dough Alphabet Cards

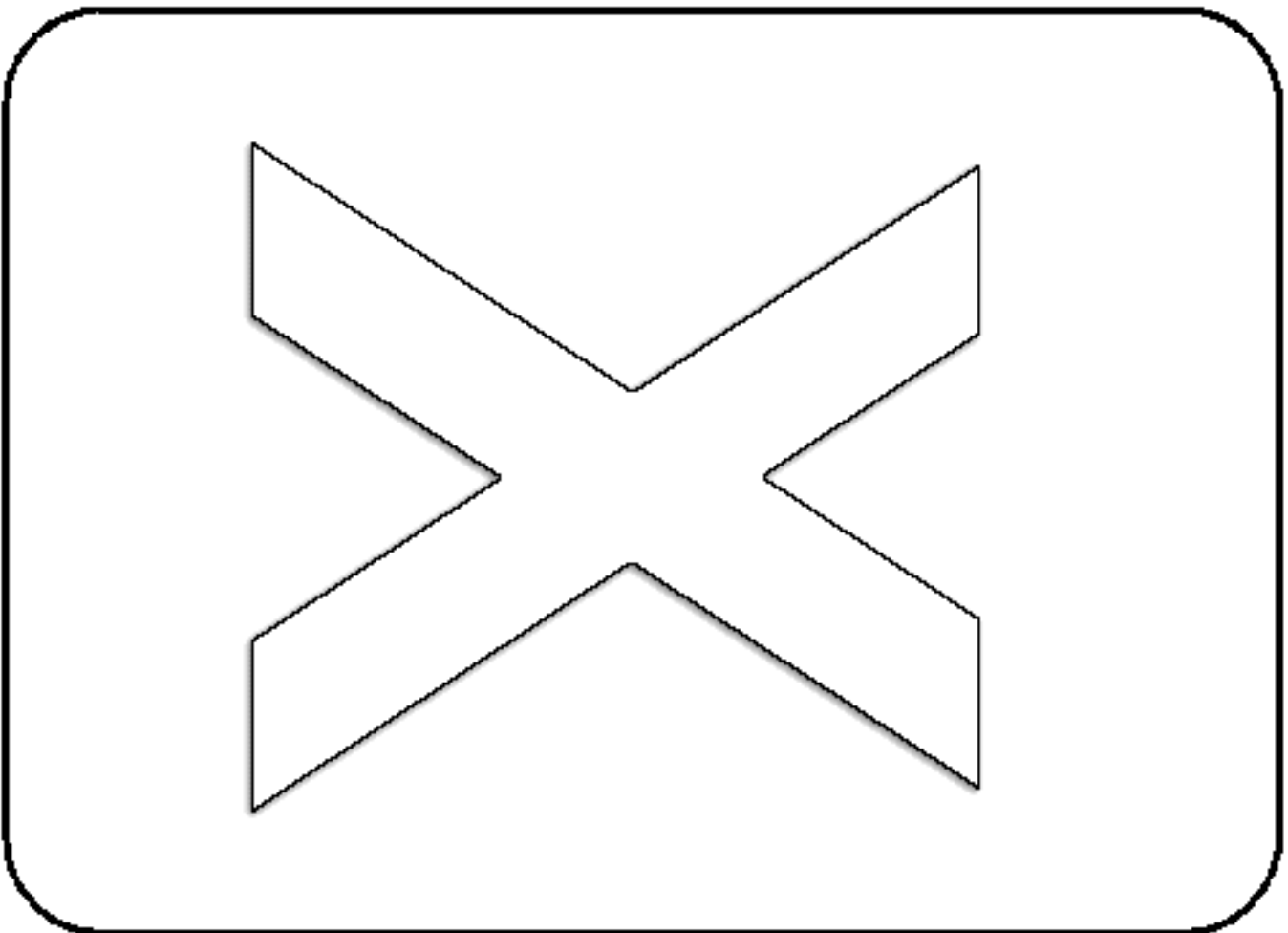
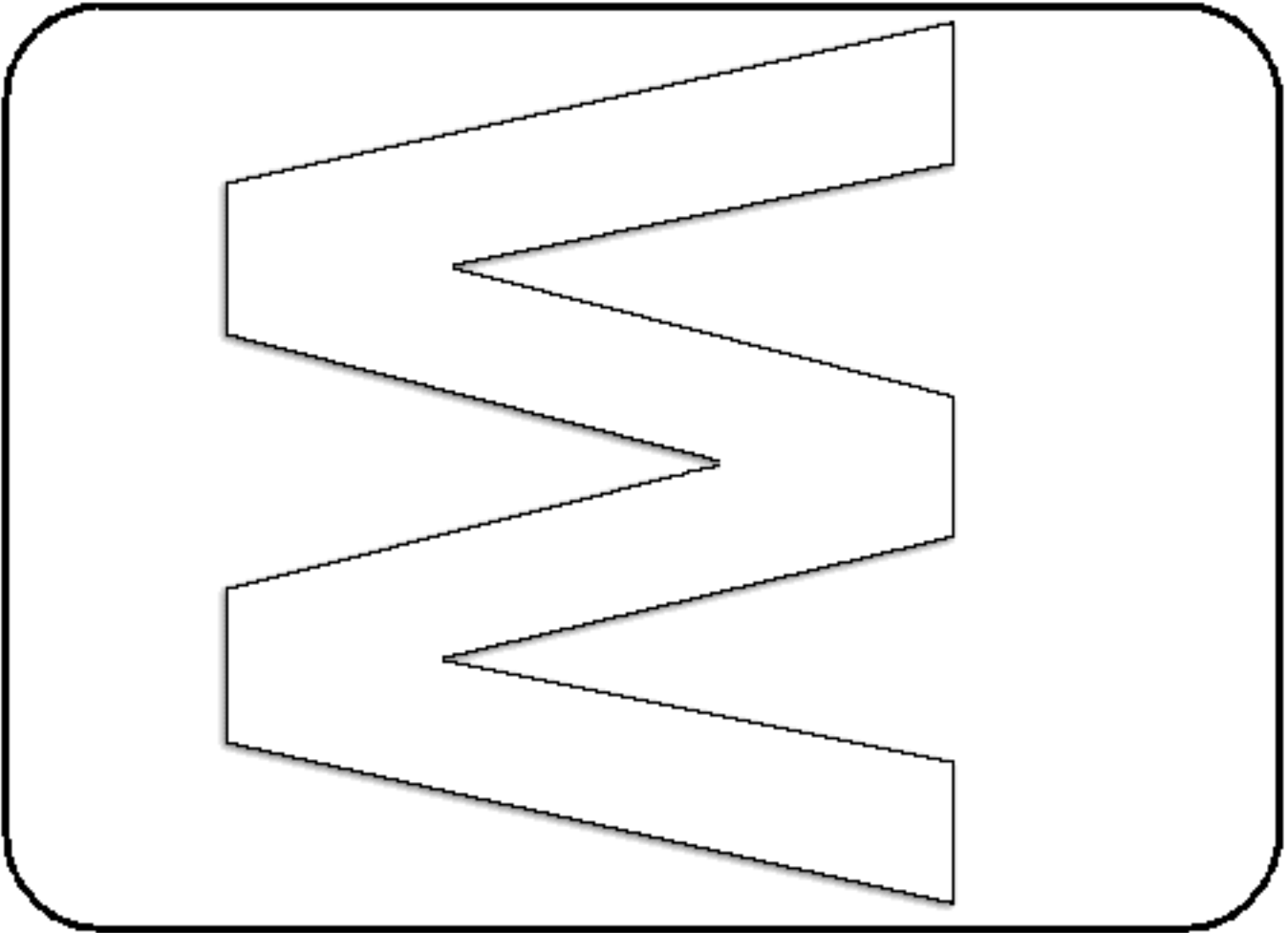

Play Dough Alphabet Cards

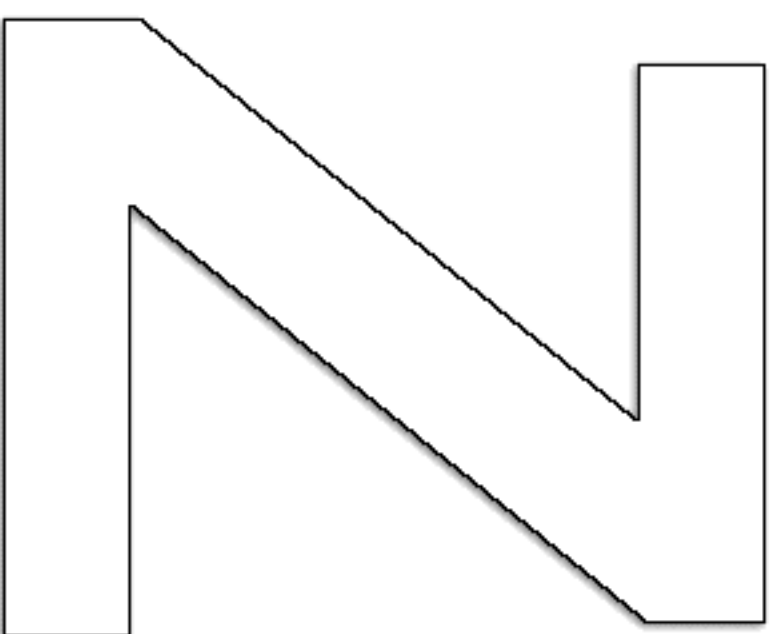
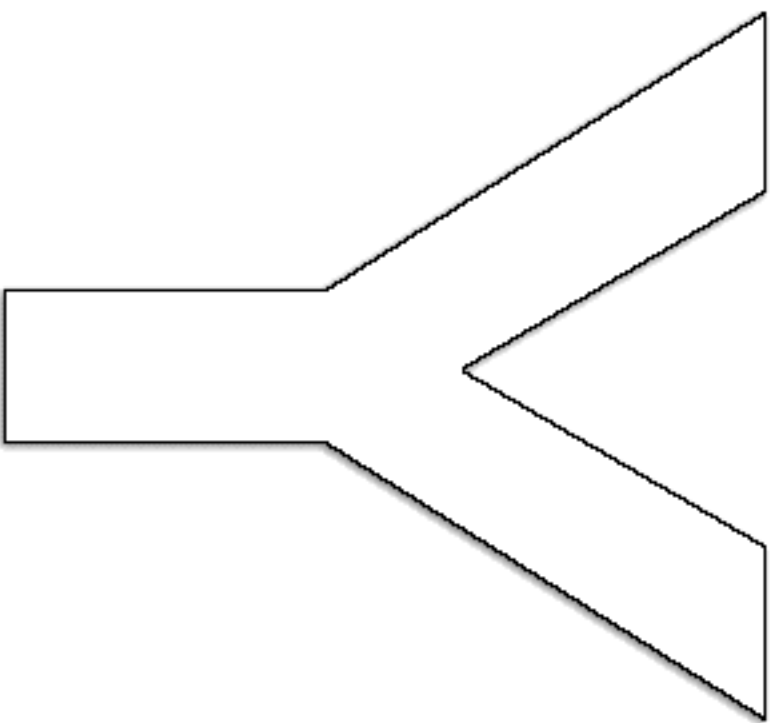

Play Dough Alphabet Cards

Instructions: Print on cardstock paper ... cut out and laminate. Children use playdough to fill the inside of each letter. They can make playdough balls or "snakes" etc. This is a great activity for both letter identification and fine motor skills development.